



DDZ9681 - DDZ9717

SURFACE MOUNT PRECISION ZENER DIODE

Features

- 500mW Power Dissipation on Ceramic PCB
- Very Tight Tolerance on V_z
- Ideally Suited for Automated Assembly Processes
- **Lead Free By Design/RoHS Compliant (Note 2)**

Mechanical Data

- Case: SOD-123
- Case Material: Molded Plastic. UL Flammability Classification Rating 94V-0
- Moisture Sensitivity: Level 1 per J-STD-020C
- Terminal Connections: Cathode Band
- Terminals: Finish - Matte Tin annealed over Alloy 42 leadframe. Solderable per MIL-STD-202, Method 208
- Marking & Type Code Information: See Electrical Specifications Table
- Ordering Information: See Page 7
- Weight: 0.01 grams (approximate)

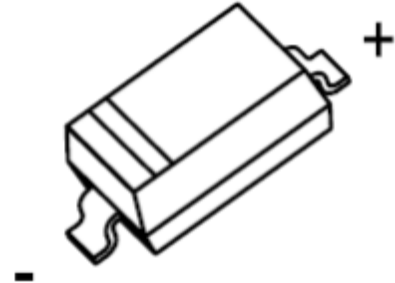

SOD-123

Maximum Ratings @ $T_A = 25^\circ\text{C}$ unless otherwise specified

Characteristic	Symbol	Value	Unit
Forward Voltage @ $I_F = 10\text{mA}$	V_F	0.9	V
Operating and Storage Temperature Range	T_j, T_{STG}	-65 to +150	$^\circ\text{C}$

Thermal Characteristics

Characteristic	Symbol	Value	Unit
Power Dissipation (Note 1)	P_d	500	mW
Thermal Resistance, Junction to Ambient Air (Note 1)	$R_{\theta JA}$	305	$^\circ\text{C/W}$

- Note:
1. Device mounted on ceramic PCB = 7.6mm x 9.4mm x 0.87mm with pad areas 25mm² at $T_A = 25^\circ\text{C}$ or mounted on FR-5 = 3.5x1.5 inches with recommended pad layout, which can be found on our website at <http://www.diodes.com/datasheets/ap02001.pdf>, at $T_L = 75^\circ\text{C}$.
 2. No purposefully added lead.



Electrical Characteristics @ T_A = 25°C unless otherwise specified

Type Number	Type Code	Zener Voltage Range (Note 3)				Maximum Reverse Leakage Current (Note 4)	
		V _Z @ I _{ZT}			I _{ZT}	I _R @ V _R	
		Nom (V)	Min (V)	Max (V)	μA	μA	V
DDZ9681	H9	2.4	2.28	2.52	50	2	1
DDZ9682	HA	2.7	2.565	2.835	50	1	1
DDZ9683	HB	3.0	2.85	3.15	50	0.8	1
DDZ9684	HC	3.3	3.13	3.47	50	7.5	1.5
DDZ9685	HD	3.6	3.42	3.78	50	7.5	2
DDZ9686	HE	3.9	3.70	4.10	50	5	2
DDZ9687	HF	4.3	4.09	4.52	50	4	2
DDZ9688	HG	4.7	4.47	4.94	50	5	3
DDZ9689	HH	5.1	4.85	5.36	50	5	3
DDZ9690	HJ	5.6	5.32	5.88	50	2	4
DDZ9691	HK	6.2	5.89	6.51	50	1	5
DDZ9692	HL	6.8	6.46	7.14	50	0.1	5.1
DDZ9693	HM	7.5	7.13	7.88	50	0.1	5.7
DDZ9694	HN	8.2	7.79	8.61	50	0.1	6.2
DDZ9696	HP	9.1	8.65	9.56	50	0.1	6.9
DDZ9697	HQ	10	9.50	10.50	50	0.1	7.6
DDZ9698	HR	11	10.45	11.55	50	0.05	8.4
DDZ9699	HS	12	11.40	12.60	50	0.05	9.1
DDZ9700	HT	13	12.35	13.65	50	0.05	9.8
DDZ9701	HU	14	13.30	14.70	50	0.05	10.6
DDZ9702	HV	15	14.25	15.75	50	0.05	11.4
DDZ9703	HW	16	15.20	16.80	50	0.05	12.1
DDZ9704	H8	17	16.15	17.85	50	0.05	12.9
DDZ9705	HY	18	17.10	18.90	50	0.05	13.6
DDZ9707	MD	20	19.00	21.00	50	0.05	15.2
DDZ9708	ME	22	20.90	23.10	50	0.05	16.7
DDZ9709	MF	24	22.80	25.20	50	0.05	18.2
DDZ9711	MH	27	25.65	28.35	50	0.05	20.4
DDZ9712	MJ	28	26.60	29.40	50	0.05	21.2
DDZ9713	MK	30	28.50	31.50	50	0.05	22.8
DDZ9714	ML	33	31.35	34.65	50	0.05	25.0
DDZ9715	MM	36	34.20	37.80	50	0.05	27.3
DDZ9716	MN	39	37.05	40.95	50	0.05	29.6
DDZ9717	MO	43	40.85	45.15	50	0.05	32.6

Notes: 3. Nominal Zener voltage is measured with the device junction in thermal equilibrium at T_J = 30°C ± 1°C.
 4. Short duration pulse test used to minimize self-heating effect.

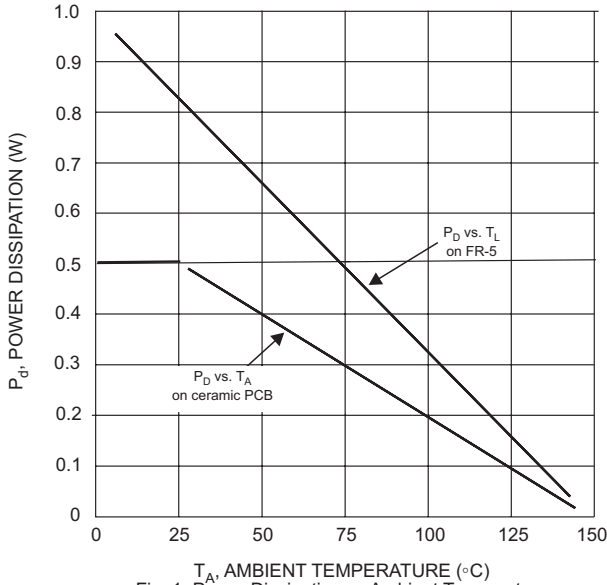

Fig. 1 Power Dissipation vs Ambient Temperature

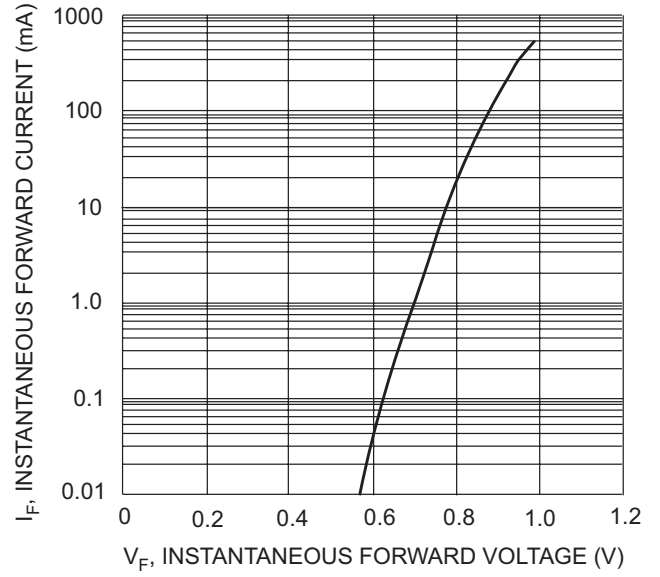

Fig. 2 Typical Forward Characteristics

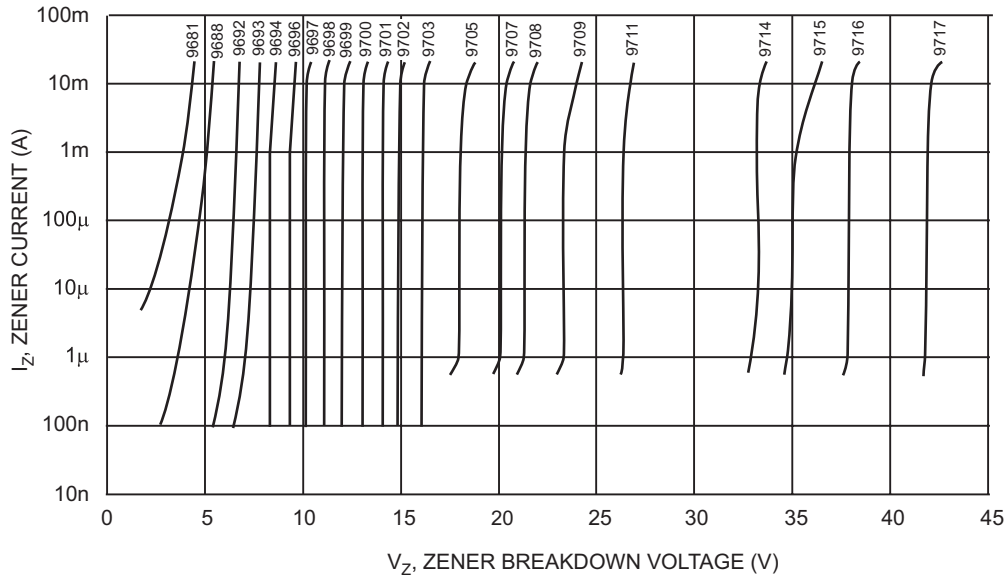

Fig. 3 Typical Reverse Characteristics

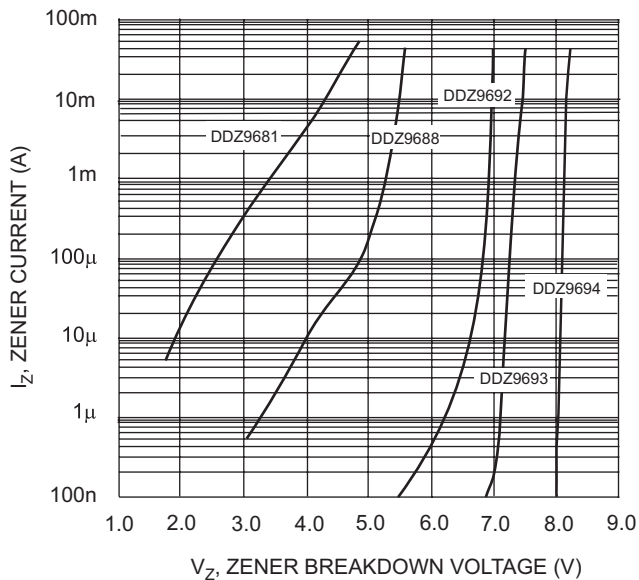

Fig. 4 Typical Reverse Characteristics, DDZ9681 - DDZ9694

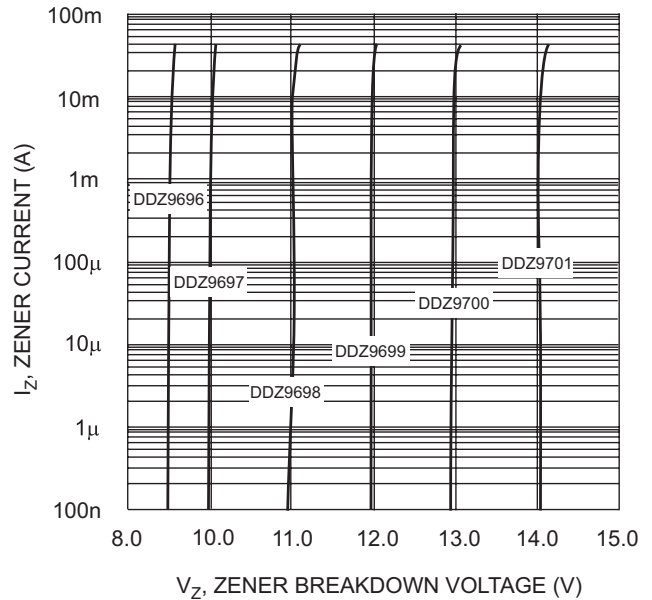

Fig. 5 Typical Reverse Characteristics, DDZ9696 - DDZ9701

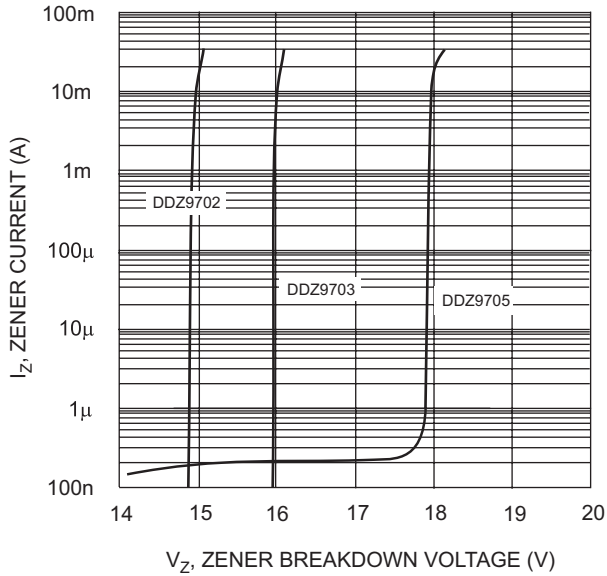

Fig. 6 Typical Reverse Characteristics, DDZ9702 - DDZ9705

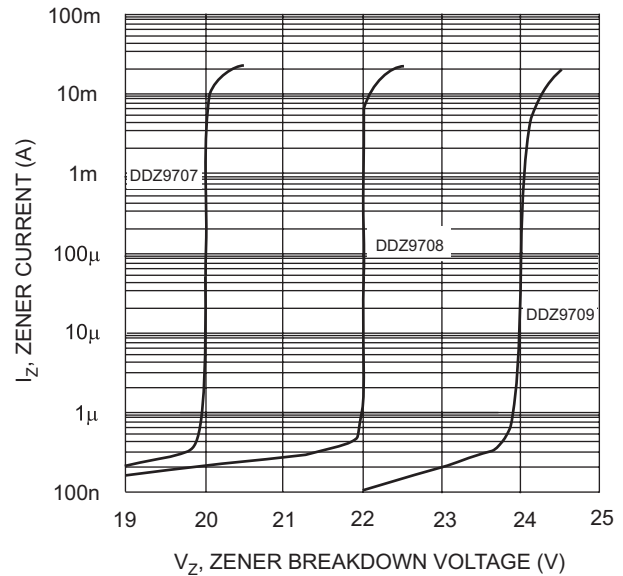

Fig. 7 Typical Reverse Characteristics, DDZ9707 - DDZ9709

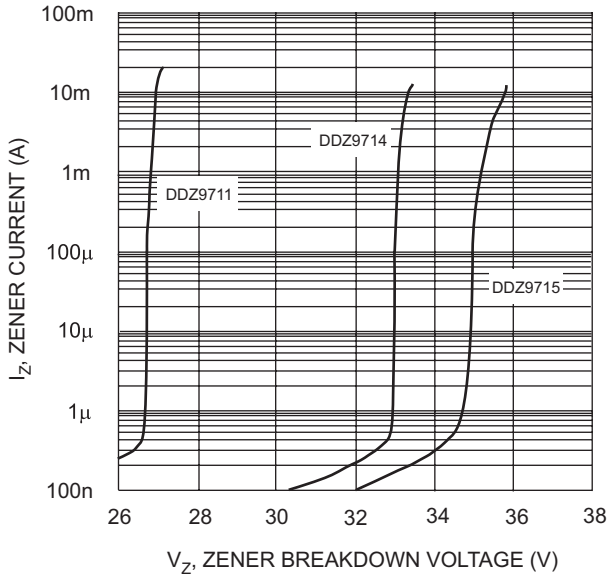

Fig. 8 Typical Reverse Characteristics, DDZ9711 - DDZ9715

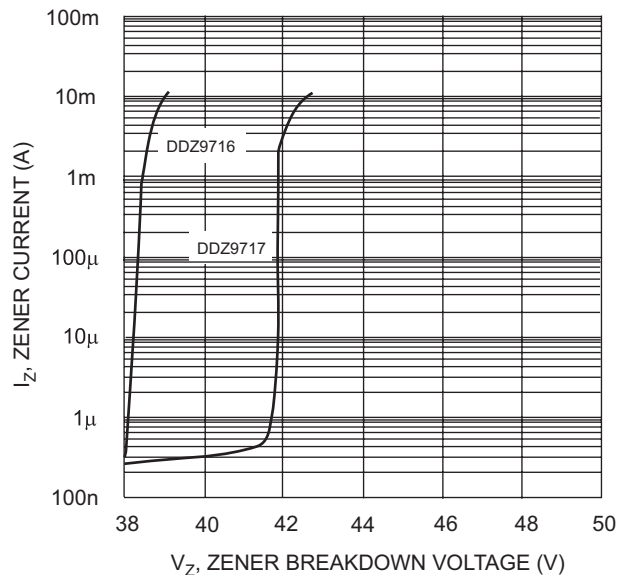

Fig. 9 Typical Reverse Characteristics, DDZ9716 - DDZ9717

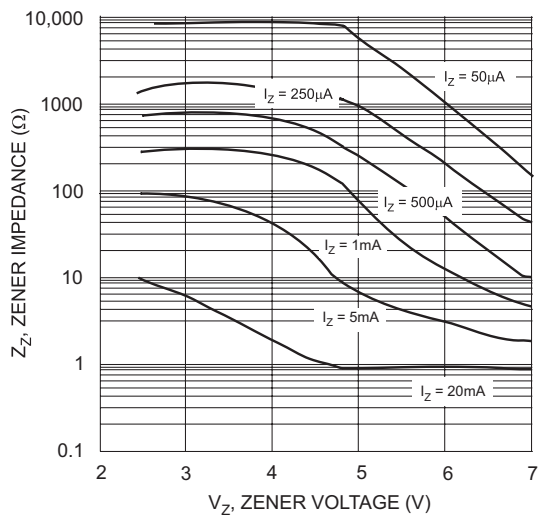

Fig. 10 Typical Zener Impedance Characteristics, DDZ9681 - DDZ9692

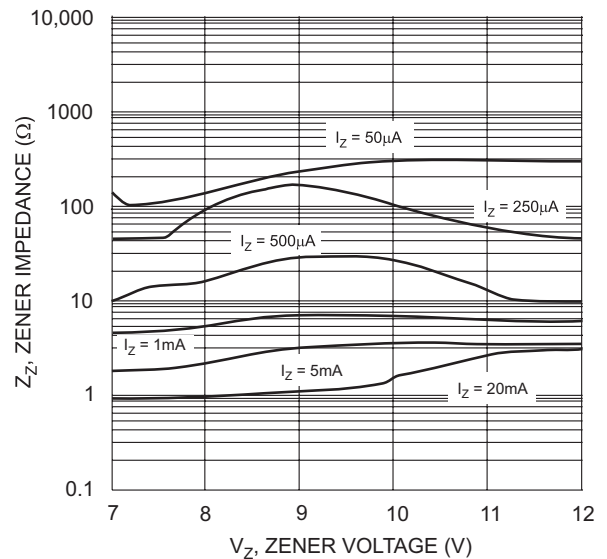

Fig. 11 Typical Zener Impedance Characteristics, DDZ9693 - DDZ9699

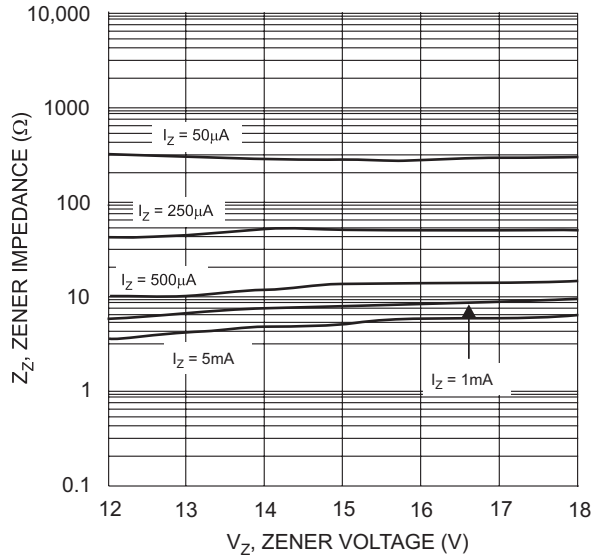

Fig. 12 Typical Zener Impedance Characteristics, DDZ9699 - DDZ9705

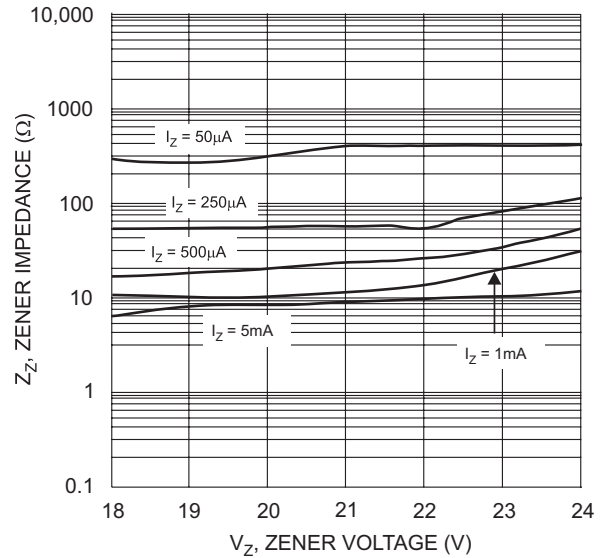

Fig. 13 Typical Zener Impedance Characteristics, DDZ9705 - DDZ9709

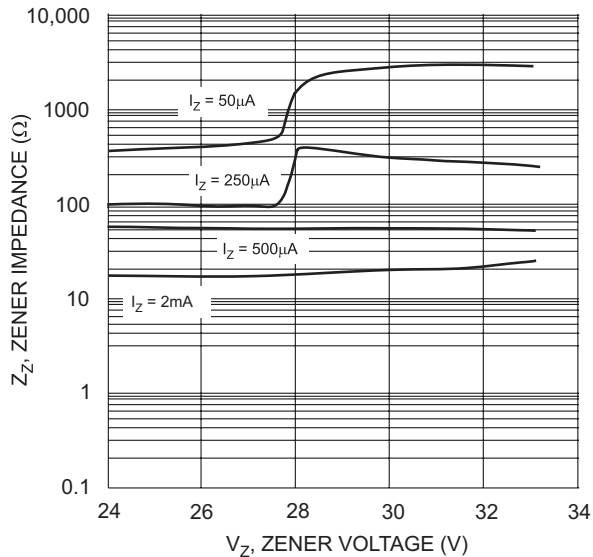

Fig. 14 Typical Zener Impedance Characteristics, DDZ9709 - DDZ9714

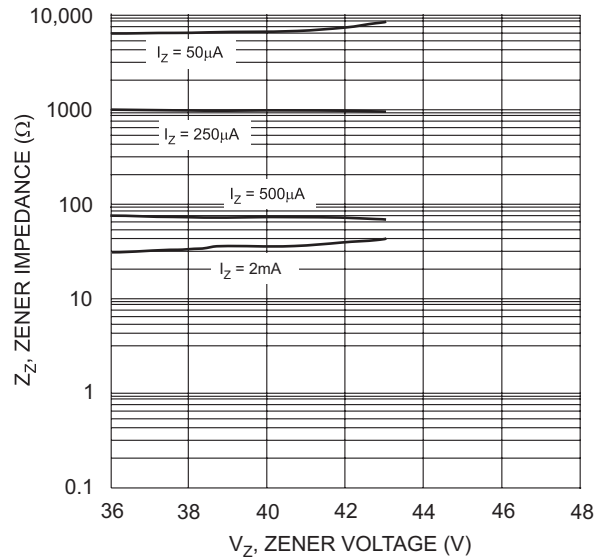

Fig. 15 Typical Zener Impedance Characteristics, DDZ9715 - DDZ9717

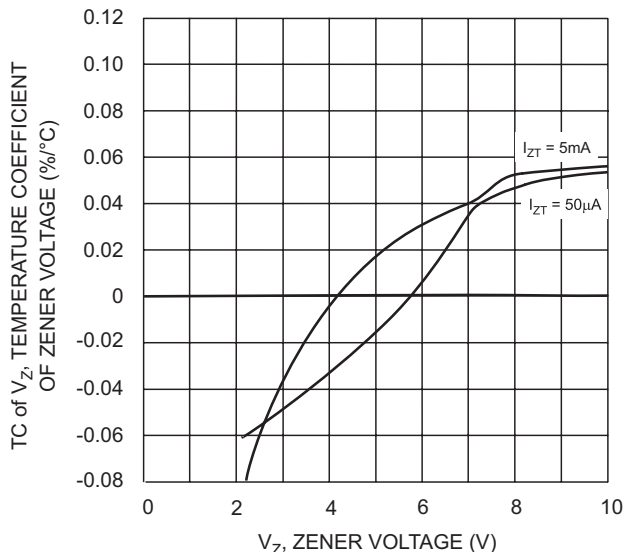

Fig. 16 Typical Temperature Coefficient of Zener Voltage vs. Zener Voltage, DDZ9681 - DDZ9697

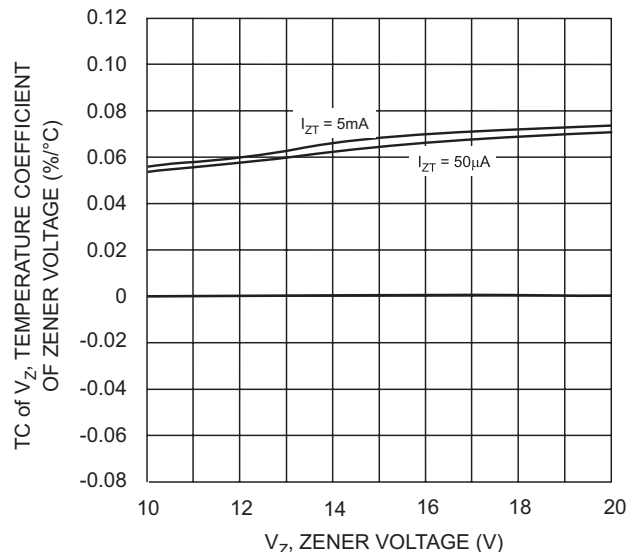

Fig. 17 Typical Temperature Coefficient of Zener Voltage vs. Zener Voltage, DDZ9697 - DDZ9707

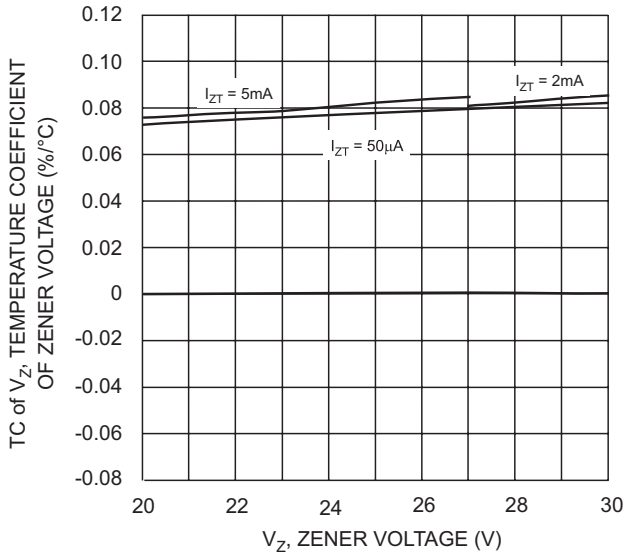

Fig. 18 Typical Temperature Coefficient of Zener Voltage, DDZ9707 - DDZ9713

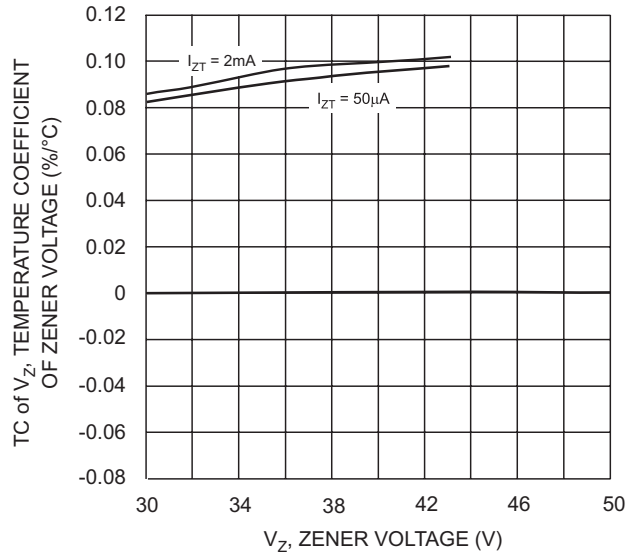

Fig. 19 Typical Temperature Coefficient of Zener Voltage, DDZ9713 - DDZ9717

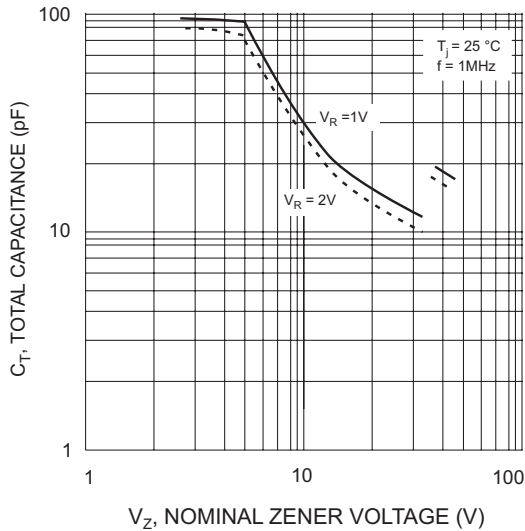

Fig. 20 Total Capacitance vs Nominal Zener Voltage

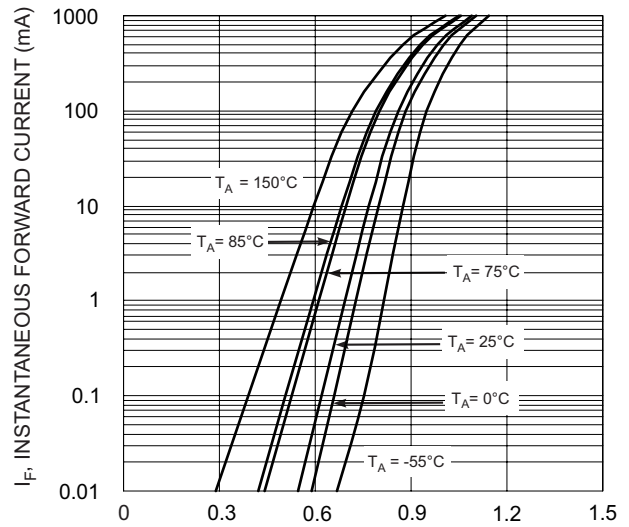

Fig. 21 Typical Forward Characteristics, DDZ9681

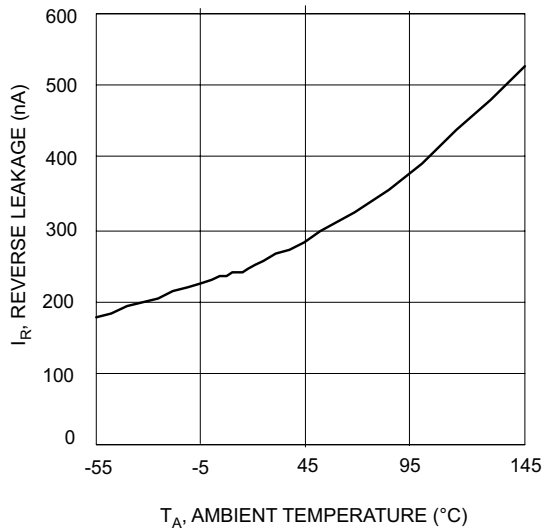

Fig. 22 Typical Leakage vs. Ambient Temperature, DDZ9681



PACKAGE OUTLINE

Plastic surface mounted package; 2 leads

SOD-123

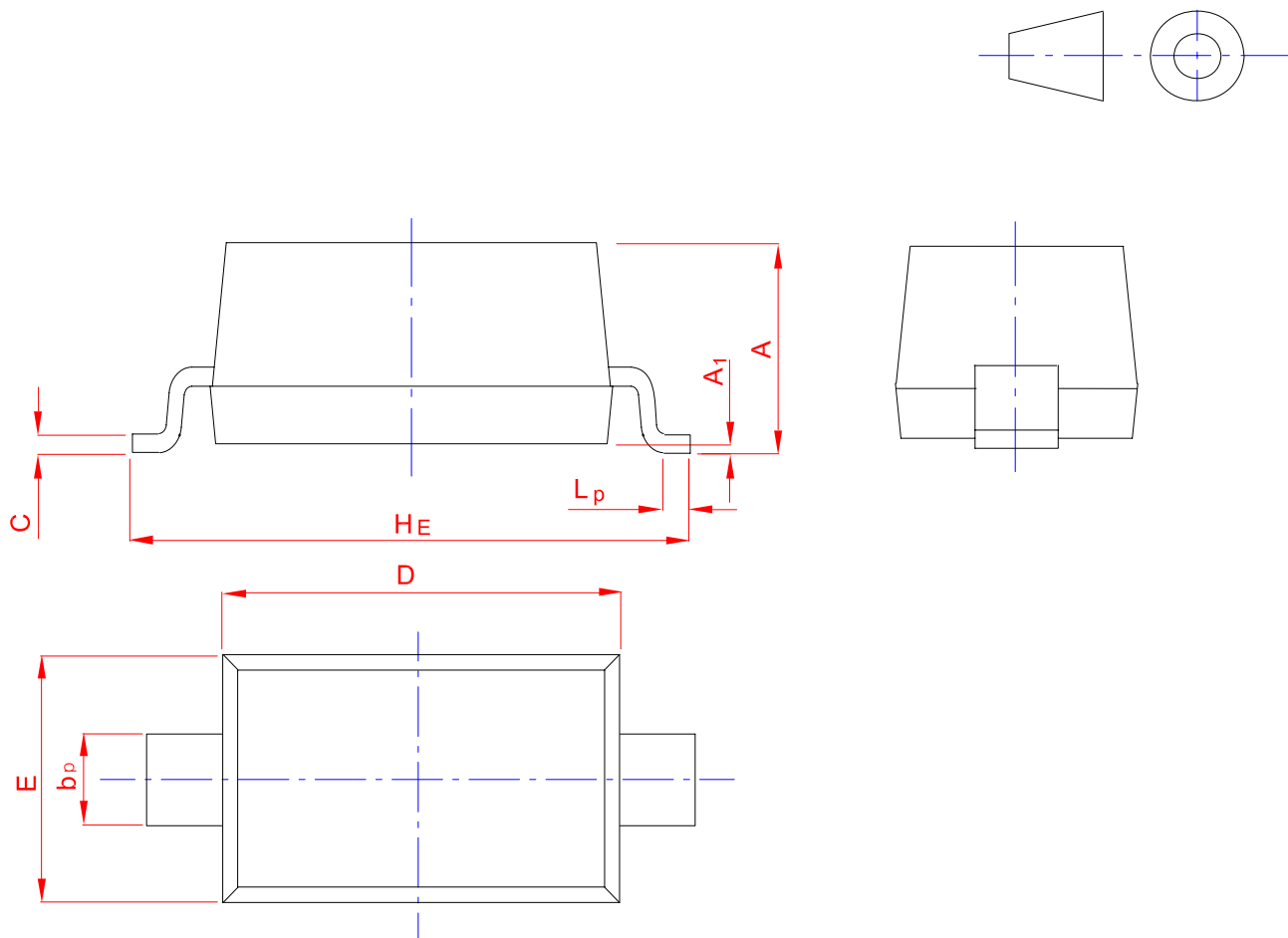

UNIT	A	b _p	C	D	E	H _E	A ₁	L _p
mm	1.20	0.60	0.135	2.75	1.65	3.85	0.10	0.50
	0.90	0.50	0.100	2.55	1.55	3.55	0.01	0.20